



**Series 9342P Hydraulically-Driven
Polypropylene Transfer Pump**

Form L-1499
02/10

Installation, Operation, Repair and Parts Manual

Description

Hypro Self-Priming Polypropylene Centrifugal Pumps handle big, high-capacity, liquid transfer jobs with ease. Use them for transferring water, liquid fertilizers, and other chemicals compatible with pump materials.

Make short work of other farm jobs: filling nurse tanks, watering seedbeds, and transferring liquids. This self-priming model makes it ideal for de-watering applications.



- Max. Flow Rate200 GPM**
- Max. Pressure60 PSI**
- Ports2" NPT Inlet**
-2" NPT Outlet**
- Hydraulic Ports1/2" NPT Inlet**
-1/2" NPT Tank**

General Safety Information

[NOTE]

Notes are used to notify of installation, operation, or maintenance information that is important but not safety related.

[CAUTION]

Caution is used to indicate the presence of a hazard, which will or may cause minor injury or property damage if the notice is ignored

[WARNING]

Warning denotes that a potential hazard exists and indicates procedures that must be followed exactly to either eliminate or reduce the hazard, and to avoid serious personal injury, or prevent future safety problems with the product.

[DANGER]

Danger is used to indicate the presence of a hazard that will result in severe personal injury, death, or property damage if the notice is ignored.

[DANGER]

Do not pump flammable or explosive fluids such as gasoline, fuel oil, kerosene, etc. Do not use in explosive atmospheres. The pump should be used only with liquids compatible with the pump component materials. Failure to follow this notice may result in severe personal injury and/or property damage and will void the product warranty.

[CAUTION]

1. Do not pump at pressures higher than the maximum recommended pressure.
2. Maximum liquid temperature is 140° F.
3. Disconnect power before servicing.
4. Release all pressure within the system before servicing any component.
5. Drain all liquids from the system before servicing any component. Flush with water.
6. Secure the outlet lines before starting the pump. An unsecured line may whip, causing personal injury and/or property damage.
7. Check hose for weak or worn condition before each use. Make certain that all connections are tightly secured.
8. Periodically inspect the pump and the system components. Perform routine maintenance as required (See Repair Instructions).
9. Use only pipe, hose and fittings rated for the maximum psi rating of the pump.
10. Do not use these pumps for pumping water or other liquids for human or animal consumption.

Hazardous Substance Alert

[CAUTION]

1. Always drain and flush pump before servicing or disassembling for any reason.
2. Always drain and flush pump prior to returning unit for repair.
3. Never store pumps containing hazardous chemicals.
4. Before returning pump for service/repair, drain out all liquids and flush unit with neutralizing liquid. Then, drain the pump. Attach tag or include written notice certifying that this has been done. It is illegal to ship or transport any hazardous chemicals without United States Environmental Protection Agency Licensing.

[DANGER]

Never use your hand to check the condition of hydraulic lines or hoses. If hydraulic fluid penetrates the skin, get medical help immediately. Failure to get proper medical help may result in loss of limb or life. The safest way to check hydraulic lines or hoses is by holding a piece of cardboard next to the hydraulic line or hose.

[WARNING]

The sound pressure level of the Pump is 80dBA. Observe all safety precautions when operating the pump within close proximity for extended periods of time by wearing hearing protectors. Extended exposure to elevated sound levels will result in permanent loss of hearing acuteness, tinnitus, tiredness, stress, and other effects such as loss of balance and awareness.

General Information—Hydraulic Systems

Hydraulic Pumps

Hydraulic pumps come in two basic types:

- **Constant displacement** - which will continue to put out its rated flow regardless of pressure, until the relief valve bypasses the flow.
- **Variable displacement** - which will produce only the flow needed by the implement until the total pump output is reached. If less than the full pump output is required, an automatic stroke control mechanism decreases the pump output to maintain a constant pressure and flow. The output varies according to demand.

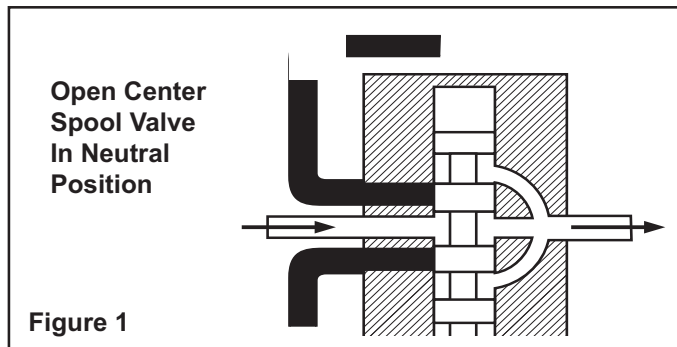

Spool Valves

There are two basic types of spool valves used in conjunction with these pumps — Open and Closed Center. In the Open Center Valve (See Figure 1), the flow goes straight through the valve when in the neutral position. This type is used for constant displacement pumps where the flow should never be shut off.

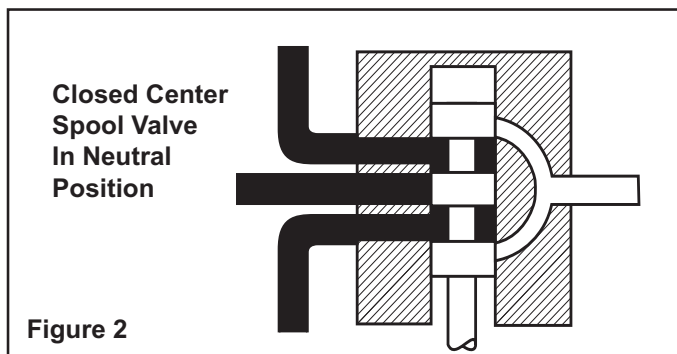

The Closed Center Valve (See Figure 2) is used with variable displacement pumps. The flow is completely shut off in the neutral position, causing the pump stroke to adjust to zero flow. The flow stops, but the pump maintains a static pressure up to the valve.

Hydraulic Motors

Figure 3 shows an internal gear motor (Gerotor) where pressure causes the cavities between the gears to expand on one side, developing torque. The Gerotor type of hydraulic motor is used on Hypro pumps for its superior performance characteristics, including cooler running and higher rpm capabilities.

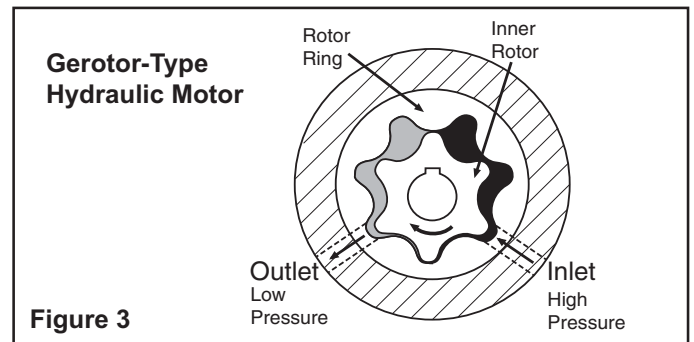

Three Systems

Fitting these components together and installing a motor, we have one of the three types of systems: Open Center, Closed Center (pressure compensated) and Closed Center Load Sensing (flow and pressure compensated).

Open Center Systems

In an Open Center System, the hydraulic pump puts out a constant flow. If the pump puts out more oil than the motor can use, a portion of the oil must be bypassed around the motor. When the oil is bypassed around a loop and does no work, the energy put into it by the pump turns into heat. Therefore, the amount of oil bypassed should be kept to a minimum. Use the largest motor possible.

Closed Center (Pressure-Compensated) Systems

The Closed Center Pressure-Compensated system has a variable displacement pump which will deliver flow at the necessary rate to maintain a specified pressure.

Note: This pump is not configured for use with these systems.

Closed Center Load Sensing Systems (Flow and Pressure-Compensating)

The Closed Center Flow-Compensated System is a variation of the pressure-compensated system, designed primarily for more efficient operation and the generation of less heat. It works on the principle of maintaining a constant pressure drop from the pump to the work port of the selector valve. Any variation in demand at the motor will cause a change in flow. The system senses this change in flow due to the change in pressure drop across the valve and causes the pump to compensate by varying the pump flow. No restrictor is used in the pressure line and no oil is bypassed.

Installation Instructions

All Models — Open Center Systems

Models include Tank Port Adapter with built-in Check Valve Assembly and Pressure Port Adapter.

Preliminary to Mounting

Consult the owners manual to determine the type and capacity of the hydraulic system. Make sure the hydraulic system is recommended to operate with a continuous load. Refer to the Pump Selection Guide to confirm you have the proper pump for your hydraulic system.

Check to see that the pump impeller can be turned by hand. (Turn the shaft clockwise using a deep socket wrench on the impeller nut.) If it cannot be turned, open the pump casing to look for obstructions. Clean out any corrosion buildup where the casing fits over the eye of the impeller.

Pump Inlet Line

To achieve full capacity from the pump, the inlet line should be at least the same size as the inlet port on the pump. Reducing this line size will restrict the capabilities of the pump. The line must also be free of air leaks. Check all fittings and connections in the suction line for tightness. The introduction of air may affect the priming and pumping capabilities of the pump. Use good quality suction hose that will not be collapsed by suction.

Pump Outlet Line

The recommended orientation for the outlet port is pointing straight up. This allows liquid to stay in the pump while it is priming. The outlet line should be the same size as the pressure port on the pump to give the optimal flow. The line should have as few restrictions and elbows as possible to optimize the pump performance and reduce pressure drop from the pump to the discharge point.

Priming the Pump

NOTE

The pump must not be run dry.

Before starting the pump, the chamber needs to be filled with liquid. The pump must not be run unless it is completely filled with liquid because there is a danger of damaging the mechanical seal, which depends on the liquid for its lubrication.

Self-priming models can be primed by removing the top vent plug and filling the priming chamber. The priming chamber will fill to the level of the inlet port. After use, the priming chamber should be flushed and drained to avoid chemical corrosion and damage from freezing. Drain by removing the lower drain plug.

Hooking Up the Hydraulic Motor to the Tractor Hydraulic System

Hypro Series 9300HMC hydraulic motor-driven pumps can be mounted on either the tractor or sprayer. When hooking up, make sure that no dirt or liquid gets into the hydraulic motor. **Keep all hydraulic connections clean.** Be sure to connect the hydraulic motor into the system correctly by putting the pressure line to the pressure port adapter and return line to the tank port adapter. The port adapters on the hydraulic motor are sized to accommodate 1/2" NPT fittings. For maximum performance, the hydraulic lines should also be at least 1/2" [12.7 mm] in size. For lines longer than 8 feet [2.44 m], hydraulic line size should be at least 3/4" [19.05 mm] in order to reduce heat generation.

The tank (**OUT**) port adapter with a built-in check valve assembly will guard against reverse operation — allowing you to reverse oil flow to operate other equipment. **This adapter must not be removed.** Standard spool valves, which are found on all tractor hydraulic systems, may cause potentially damaging high peak pressures in the hydraulic system when closed, because of abrupt shut-off of oil flow in both the supply and return lines. When shutting off the pump, move the selector to the **FLOAT** position to allow the centrifugal pump to come to a stop gradually.

Operation

Open Center Systems - All Models Adjusting Centrifugal Pump Output

NOTE

1. Install a shut-off valve and pressure gauge on the discharge line for initial setup.
2. Open the bypass adjustment screw 2-1/2 turns from fully closed. Turn the bypass screw in to achieve the flow for the desired gpm and psi.
3. Start the tractor. Leave the directional valve in the neutral position and allow hydraulic oil to circulate for approximately 10 to 15 minutes or until adequately warmed.
4. Prime the centrifugal pump with all valves open (See the Installation Instructions and System Configuration Diagram).
5. Once the pump is primed, shut off the discharge line and monitor the pressure. Shut-off pressure is not to exceed 60 PSI. Adjust discharge screw accordingly.

Closed Center (Load Sensing) All Models

Many tractors are being introduced with load sensing systems (also referred to as flow and pressure-compensated systems) which simplify system setup and eliminate many of the problems associated with using the wrong size pump motors on a given hydraulic system. Usually, any of Hypro's 9300HMC models may be used on this type of system, provided the hydraulic system produces sufficient oil flow for the hydraulic motor being used (Refer to the Pump Selection Guide).

This system maintains a constant flow of hydraulic oil for a given pressure drop. The flow is adjustable with a flow control valve installed in the hydraulic system (such as the Tortoise/Hare control on John Deere tractors). Because this system has adjustable flow, there is no need to bypass hydraulic oil as in an open center system, or to restrict the flow with orifices as in a closed center pressure-compensated system.

Adjusting Centrifugal Pump Output

1. Install a shut-off valve and pressure gauge on the discharge line for initial setup.
2. Close and lock down the bypass adjusting screw in the hydraulic motor.
3. Set the tractor hydraulic flow control valve for minimum hydraulic oil flow to the remote outlet (Tortoise position).
4. Start the tractor and allow the hydraulic oil to circulate for approximately 10 to 15 minutes or until adequately warmed.
5. Prime the centrifugal pump with all valves open (See the Installation Instructions and System Configuration Diagram).
6. Shut off the discharge valve and monitor the pressure. Slowly adjust the tractor hydraulic flow control valve until the pump deadhead pressure approaches 60 PSI.

Storage

1. Drain pump. Flush pump after use.
One of the most common causes for faulty pump performance is gumming or corrosion inside the pump. Flush the pump and entire system with a solution that will chemically neutralize the liquid pumped. Mix according to the manufacturer's directions. This will dissolve most residues remaining in the pump, leaving the inside of the pump clean and ready for use.
2. Store pump in a clean, dry environment.

Repair Instructions

Always flush pump with water or neutralizing agent before servicing.

Refer to parts breakdown on Page 9 for reference numbers.

PUMP HOUSING DISASSEMBLY

Seal replacement requires that the pump be fully removed from the hydraulic motor. Observe carefully the disassembly process to ensure an easy assembly process. Replace all worn and eroded parts.

1. Remove the 10 bolts and nuts (Ref. Nos. 2, 3, 23) holding the pump casing to the casing cover using a 10mm socket and a 10mm open end wrench. Tap pump casing on the discharge port with a rubber hammer, if necessary, to break it loose from the pump flange. Remove o-ring from casing cover. Inspect parts for wear. (See Fig. 1.)
2. Remove diffuser (Ref. 10) by removing the three screws (Ref. Nos. 8, 9) with a Phillips screwdriver. Inspect parts for wear. (See Fig. 2.)
3. Remove impeller bolt (Ref. 11) with a 13mm wrench. Pry impeller (Ref. 12) off hydraulic motor shaft using two flathead screwdrivers. Inspect impeller and ceramic (Ref. 15) for wear. Ceramic surface must not be scuffed or cracked. To remove ceramic seal from impeller bore, use a small blade screwdriver to wedge the seal out. (See Fig. 3.)
4. To remove mechanical seal from pump flange, first remove the pump flange from the engine by removing the four mounting bolts with a 13mm socket. From the engine side of the pump flange, press the mechanical seal out using a 1" diameter piece of PVC pipe 4" long. Inspect parts for wear. (See Figure 4.)
5. Inspect slinger ring (Ref. 25) on hydraulic motor shaft for wear. (See Fig. 5.)

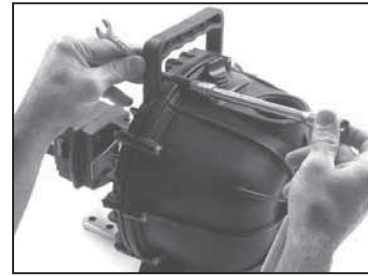

Fig. 1



Fig. 2



Fig. 3

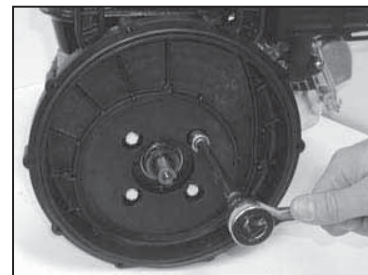

Fig. 4



Fig. 5

SEAL REPLACEMENT AND PUMP HOUSING ASSEMBLY

1. Install slinger ring (Ref. 25) on hydraulic motor shaft. (See Fig. 5.)
2. Lubricate and install the o-ring (Ref. 16) around back side of metal portion of the seal (See Fig. 6). Insert the stationary portion of the new mechanical seal (Ref. 15) by carefully pushing only on the outer metal ring as you press it into the pump flange (Ref. 22). Use a tool with 1-1/2" ID, such as 1-1/2" diameter PVC pipe, 4" long that fits over the carbon face of the seal, but pushes only on the metal ring to insert the seal. The carbon surface of the seal must be facing you during installation. Be careful to avoid scratching the seal's carbon surface. (See Fig. 7.)
3. Install washer and o-rings (Ref. 20, 21) onto the mounting bolts (Ref. 19). Apply medium strength (Blue) threadlocker onto the (4) engine mounting bolts and install the pump flange (Ref. 22). Tighten the (4) mounting bolts with a 13mm socket to a torque of 10 foot-pounds.
4. Install the shim washer (Ref. 13) and key (Ref. 14) into the bore of the impeller (Ref. 12). Lubricate the seal cavity of the impeller with WD-40, LPS or equivalent, and carefully press the seal's mating ceramic ring in place, seating it squarely on the bottom of the cavity. The glossy, finished side of the ceramic seal must be facing you. **IMPORTANT:** Make sure both seal surfaces are clean and lubricated. Never run seal surfaces dry. (See Fig. 8.)
5. Install the impeller (Ref. 12) onto the hydraulic motor shaft (Ref. 26) using the bolt, washer and seal. Bolt seal must not be worn. Tighten the impeller bolt to 10 foot-pounds. (See Fig. 9.)
6. Install flapper (Ref. 6) into diffuser (Ref. 10). Secure the perimeter of the flapper to the diffuser using the (3) Phillips head screws (Ref. 7).
7. Install diffuser (Ref. 10) onto the pump flange (Ref. 22) with three Phillips head screws (Ref. Nos. 8, 9). (See Fig. 2.)
8. Install the pump housing (Ref. 1) onto the pump flange (Ref. 22) and secure with the 10 bolts, nuts and washers, using a 10mm socket and wrench. Torque the bolts to 45-inch pounds. (See Fig. 1.)
9. Assembly and inspection is now complete.

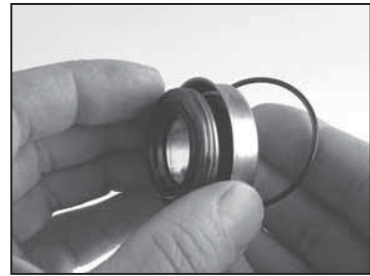

Fig. 6



Fig. 7

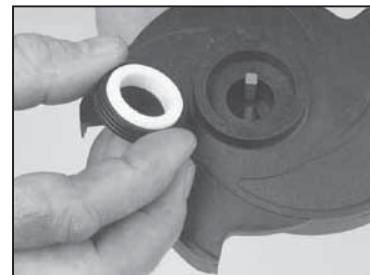

Fig. 8



Fig. 9

Model 9342P Performance Data

9342P-HM5C-5SP	Hyd. Flow	GPM at	GPM at	GPM at	GPM at	GPM at	GPM at	GPM at	GPM at	GPM at	GPM at	GPM at	GPM at	GPM at
	GPM	0 PSI	5 PSI	10 PSI	15 PSI	20 PSI	25 PSI	30 PSI	35 PSI	40 PSI	45 PSI	50 PSI	55 PSI	58 PSI
	11	206	199	189	181	169	157	145	132	117	99	79	41	0
	10	192	185	174	162	149	134	118	99	76	43	0		
9	175	167	154	139	123	105	84	55	0					

9342P-HM5C-5SP	Hyd. Flow	LPM at	LPM at	LPM at	LPM at	LPM at	LPM at	LPM at	LPM at	LPM at	LPM at	LPM at	LPM at	LPM at
	LPM	0 BAR	.34 BAR	.69 BAR	1.03 BAR	1.38 BAR	1.72 BAR	2.07 BAR	2.41 BAR	2.76 BAR	3.10 BAR	3.45 BAR	3.79 BAR	4.00 BAR
	41.6	780	752	717	687	639	595	550	499	442	375	299	153	0
	37.9	727	702	658	612	562	507	448	375	288	161	0		
34.1	662	632	582	527	467	398	316	209	0					

9342P-HM1C-5SP	Hyd. Flow	GPM at	GPM at	GPM at	GPM at	GPM at	GPM at	GPM at	GPM at	GPM at	GPM at	GPM at	GPM at	GPM at
	GPM	0 PSI	5 PSI	10 PSI	15 PSI	20 PSI	25 PSI	30 PSI	35 PSI	40 PSI	45 PSI	50 PSI	55 PSI	60 PSI
	10	200	193	184	174	164	153	141	128	114	98	80	55	0
	9	185	177	166	156	144	132	119	103	86	64	0		
8	165	155	145	134	122	109	95	78	57	0				

9342P-HM1C-5SP	Hyd. Flow	LPM at	LPM at	LPM at	LPM at	LPM at	LPM at	LPM at	LPM at	LPM at	LPM at	LPM at	LPM at	LPM at
	LPM	0 BAR	.34 BAR	.69 BAR	1.03 BAR	1.38 BAR	1.72 BAR	2.07 BAR	2.41 BAR	2.76 BAR	3.10 BAR	3.45 BAR	3.79 BAR	4.14 BAR
	37.9	757	730	695	658	620	578	534	486	433	373	301	209	0
	34.1	700	668	630	590	547	500	449	391	325	241	0		
30.3	625	588	549	507	463	413	358	294	215					

PERFORMANCE
9342P-HM5C-5SP

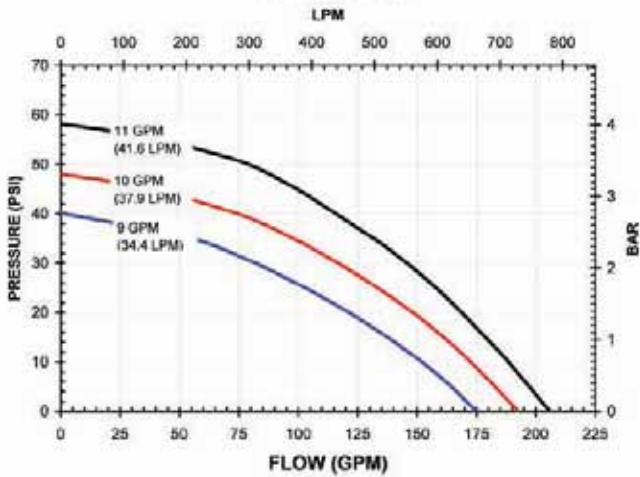

PERFORMANCE
9342P-HM1C-5SP

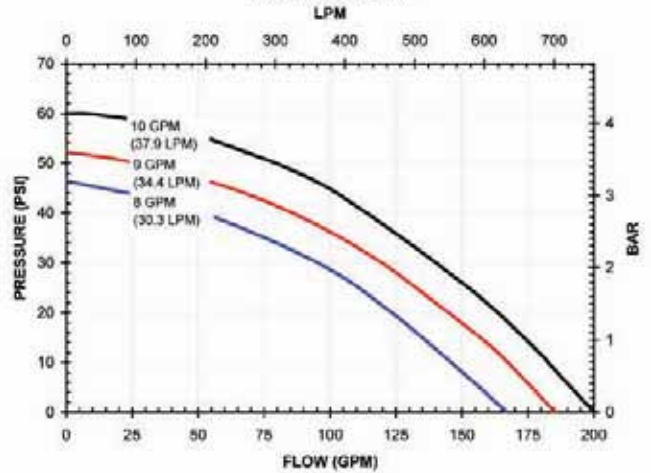

Model 9342P Parts Breakdown

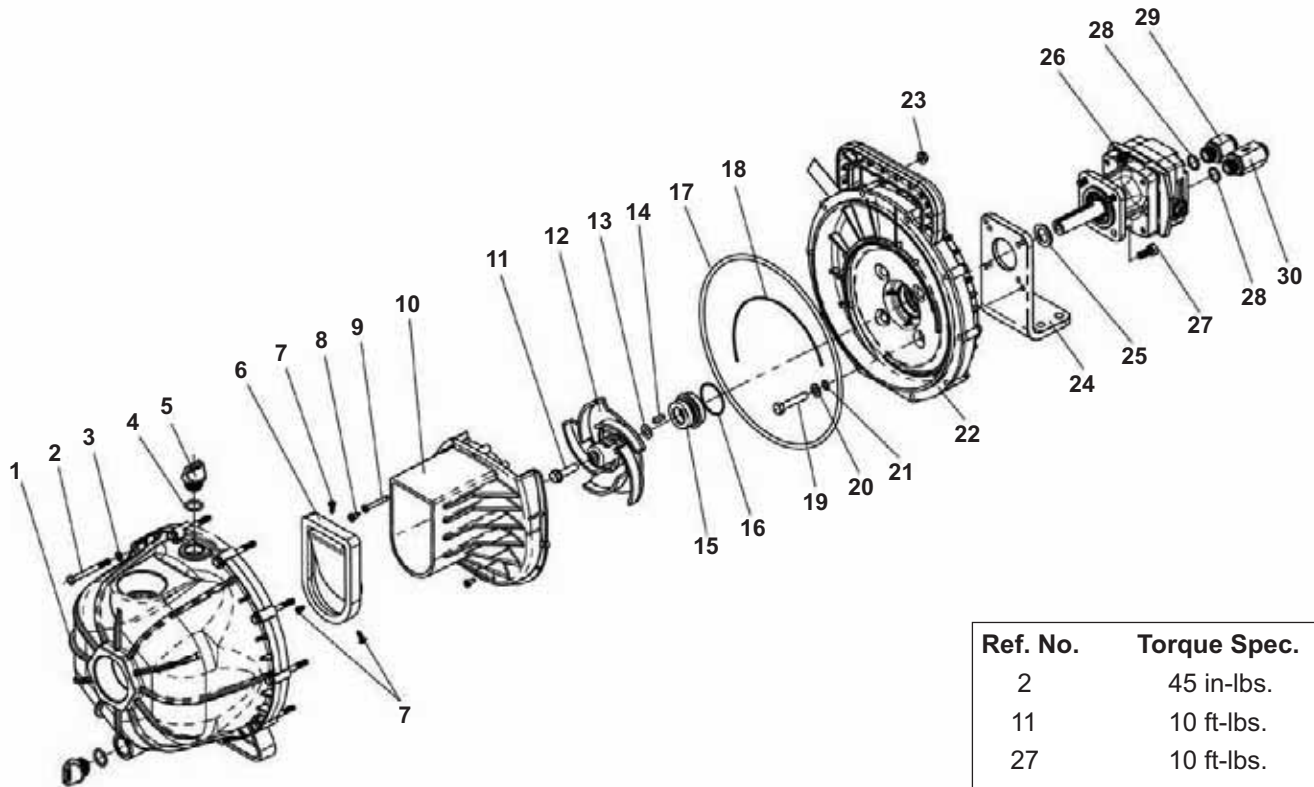

Ref. No.	Torque Spec.
2	45 in-lbs.
11	10 ft-lbs.
27	10 ft-lbs.

Seal Repair Kit 3430-0635 contains:
 (1) Ref. 18 Diffuser Gasket, (1) Ref. 17
 Pump Body O-Ring, (1) Ref. 16 Seal
 O-Ring, and (1) Ref. 15 Mechanical Seal.

Pump Head Kit 3430-0691
 contains: all items shown above,
 less hydraulic motor and mounting
 hardware (items 1-23).

Replacement hydraulic motors
 (Ref. 26) 2500-0043C & 2500-0047C
 include (1 ea.) Ref. 29 & 30 Port Adapters,
 (2) Ref. 28 O-rings, and (1) Ref. 14 Key.

Ref. No.	Qty. Reqd.	Part No.	Description
1	1	0100-1540P	Pump Housing
2	10	2210-0141	Bolt
3	10	2270-0115	Washer
4	2	1720-0230	Plug O-ring
5	2	2404-0350P	Fill/Drain Plug
6	1	1700-0208	Flapper Valve
7	3	2210-0152	Flapper Screw
8	2	2210-0145	Diffuser Mounting Screw (short)
9	1	2210-0144	Diffuser Mounting Screw (long)
10	1	0150-1540P	Diffuser
11	1	2210-0142	Impeller Bolt (with washer)
12	1	0401-1540P	Impeller
13	1	1430-0033	Shim Washer
14	1	1610-0044	Key
15	1	2120-0044	Mechanical Seal

Ref. No.	Qty. Reqd.	Part No.	Description
16	1	1720-0231	Seal O-ring
17	1	1720-0244	Pump Body O-ring
18	1	1700-0209	Diffuser Gasket
19	4	2210-0177	Hex Head Bolt
20	4	2270-0114	Flat Washer
21	4	1720-0013	O-ring
22	1	0751-1540P	Pump Flange
23	10	2250-0087	Nut
24	1	1510-0109	Motor Bracket
25	1	1410-0083	Slinger Ring
26	1	2500-0043C	Hydraulic Motor (HM5C)
26	1	2500-0047C	Hydraulic Motor (HM1C)
27	4	2210-0004	Mounting Bolt
28	2	1720-0108	O-ring
29	1	3360-0021A	Pressure Port Adapter (includes o-ring)
30	1	3320-0049A	Tank Port Adapter (includes o-ring)

Notes

Notes

Limited Warranty on Hypro/SHURflo Agricultural Pumps & Accessories

Hypro/SHURflo (hereafter, "Hypro") agricultural products are warranted to be free of defects in material and workmanship under normal use for the time periods listed below, with proof of purchase.

- Pumps: one (1) year from the date of manufacture, or one (1) year of use. This limited warranty will not exceed two (2) years, in any event.
- Accessories: ninety (90) days of use.

This limited warranty will not apply to products that were improperly installed, misapplied, damaged, altered, or incompatible with fluids or components not manufactured by Hypro. All warranty considerations are governed by Hypro's written return policy.

Hypro's obligation under this limited warranty policy is limited to the repair or replacement of the product. All returns will be tested per Hypro's factory criteria. Products found not defective (under the terms of this limited warranty) are subject to charges paid by the returnee for the testing and packaging of "tested good" non-warranty returns.

No credit or labor allowances will be given for products returned as defective. Warranty replacement will be shipped on a freight allowed basis. Hypro reserves the right to choose the method of transportation.

This limited warranty is in lieu of all other warranties, expressed or implied, and no other person is authorized to give any other warranty or assume obligation or liability on Hypro's behalf. Hypro shall not be liable for any labor, damage or other expense, nor shall Hypro be liable for any indirect, incidental or consequential damages of any kind incurred by the reason of the use or sale of any defective product. This limited warranty covers agricultural products distributed within the United States of America. Other world market areas should consult with the actual distributor for any deviation from this document.

Return Procedures

All products must be flushed of any chemical (ref. OSHA section 1910.1200 (d) (e) (f) (g) (h)) and hazardous chemicals must be labeled/tagged before being shipped* to Hypro for service or warranty consideration. Hypro reserves the right to request a Material Safety Data Sheet from the returnee for any pump/product it deems necessary. Hypro reserves the right to "disposition as scrap" products returned which contain unknown fluids. Hypro reserves the right to charge the returnee for any and all costs incurred for chemical testing, and proper disposal of components containing unknown fluids. Hypro requests this in order to protect the environment and personnel from the hazards of handling unknown fluids.

Be prepared to give Hypro full details of the problem, including the model number, date of purchase, and from whom you purchased your product. Hypro may request additional information, and may require a sketch to illustrate the problem.

Contact Hypro Service Department at 800-468-3428 to receive a Return Merchandise Authorization number (RMA#). Returns are to be shipped with the RMA number clearly marked on the outside of the package. Hypro shall not be liable for freight damage incurred during shipping. Please package all returns carefully. All products returned for warranty work should be sent **shipping charges prepaid** to:

HYPRO
Attention: Service Department
375 Fifth Avenue NW
New Brighton, MN 55112

For technical or application assistance, call the **Hypro Technical/Application number: 800-445-8360**. To obtain service or warranty assistance, call the **Hypro Service and Warranty number: 800-468-3428**; or send a fax to the **Hypro Service and Warranty FAX: 651-766-6618**.

*Carriers, including U.S.P.S., airlines, UPS, ground freight, etc., require specific identification of any hazardous material being shipped. Failure to do so may result in a substantial fine and/or prison term. Check with your shipping company for specific instructions.

Note: This warranty does not apply to Hypro Pump Kit 3430-0637. This is because the user could incorrectly assemble the parts and cause the pump to work improperly.

